

Before assembly

- We recommend that time is taken to read the instructions before starting assembly, then follow the easy step by step guide. The instruction sheet is only a guide to the assembly. Certain items may not be shown to scale.
- Check all components prior to assembly
- This product should be assembled by no less than two people.
- Never attempt to erect the assembly in high winds.



Recommended tools for assembly

- Spirit level
- Step ladder
- Alan key (provided)

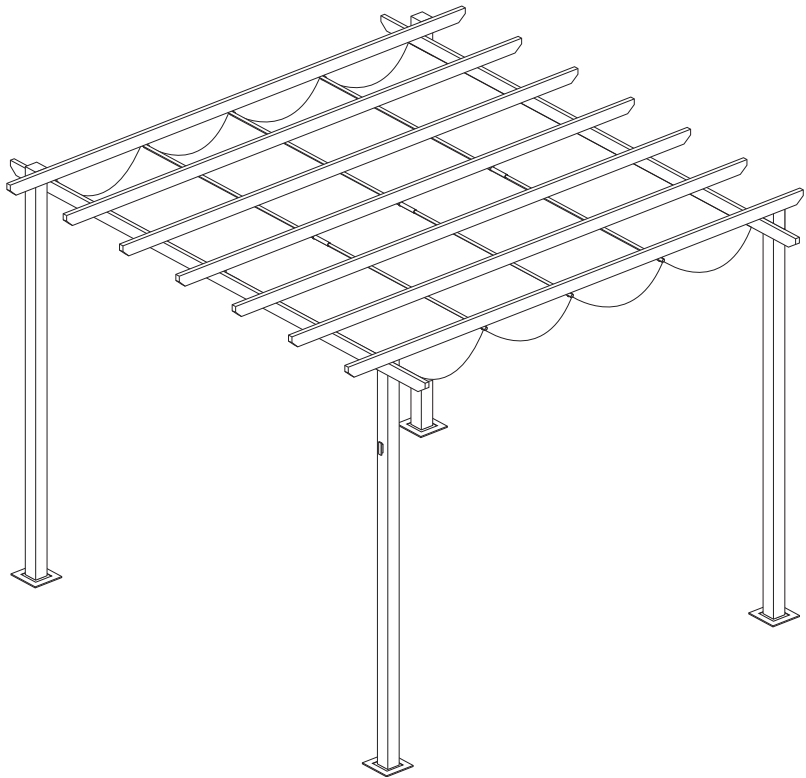



Caution

When connecting components that use the spring button. Please ensure the button is properly located in the hole.

No.	Components	Qty.
1	Front left/right back leg	2
2	Front right leg	1
3	Back left leg	1
4	Front left outer rafter half	1
5	Front right outer rafter half	1
6	Back right outer rafter half	1
7	Back left outer rafter half	1
8	Centre track and pulley mechanism	1
9	Front left/back right outer track half	2
10	Front right/back left outer track half	2
11	Centre rafter half with coupling	4
12	Centre rafter half	4
13	fixed canopy tubes	2
14	Canopy tubes	8
15	Foot plates	4
16	Polyester canopy	1
17	Runner	8

No.	Fixing Kit	Qty.
18	15mm long barrel bolts	32
19	15mm bolts	44
20	35mm bolt	4
21	85mm bolt	8
22	Plastic bolt caps	56
23	Foot pegs	16
24	Allen key	2

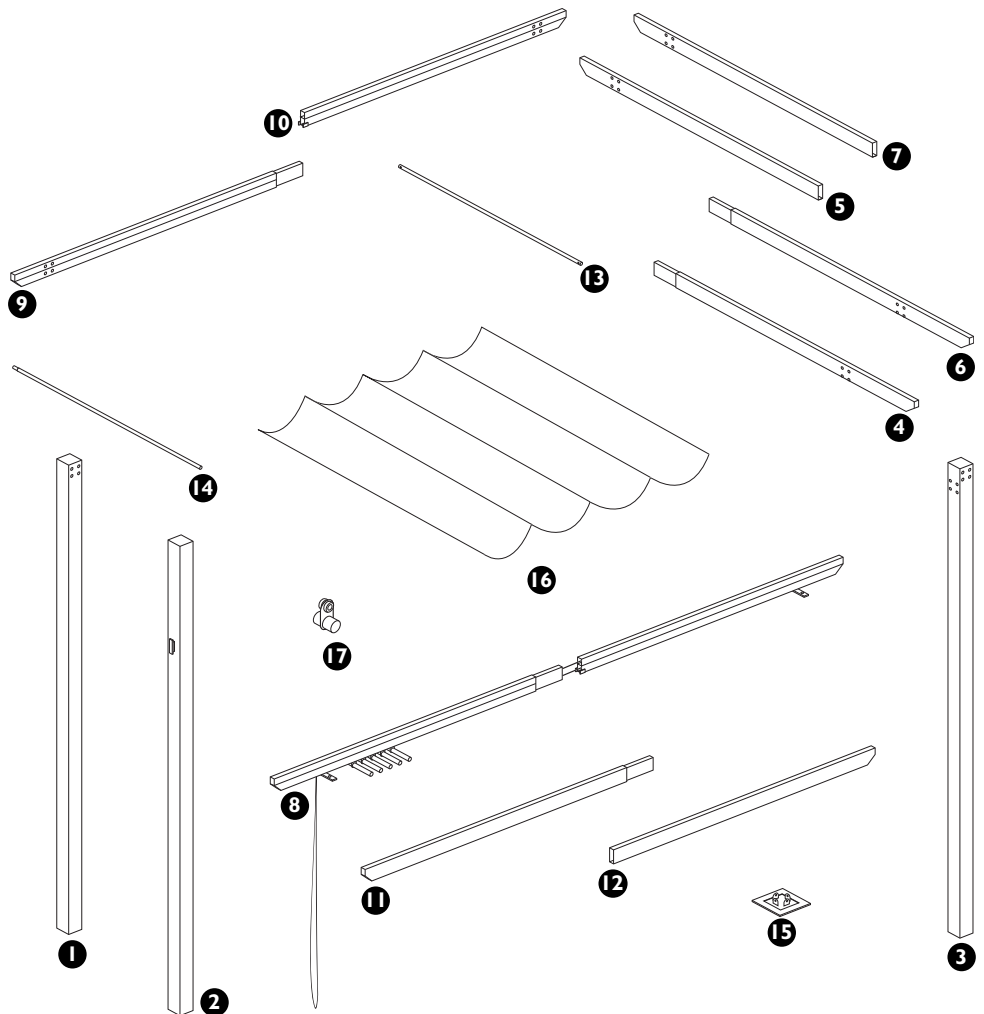

1. Feet

To the bottom of each leg secure a foot plate using 4 x 15mm bolts.

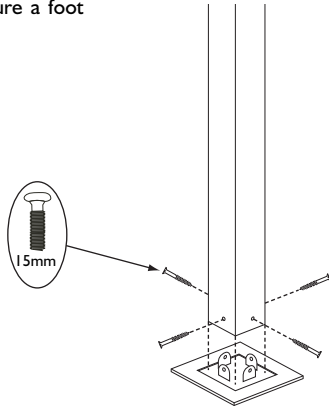

2. Outer track sections

A. Insert 4 runners into each of the 2 outer track sections as shown.

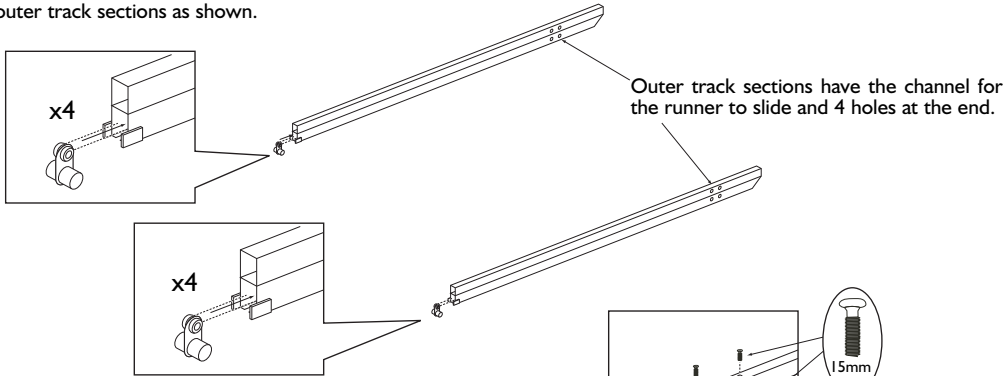

Connect the track sections to the track sections with coupling. Insert the coupling into the upper tube of the track. Secure in place using 4 x 15mm bolts for each join.

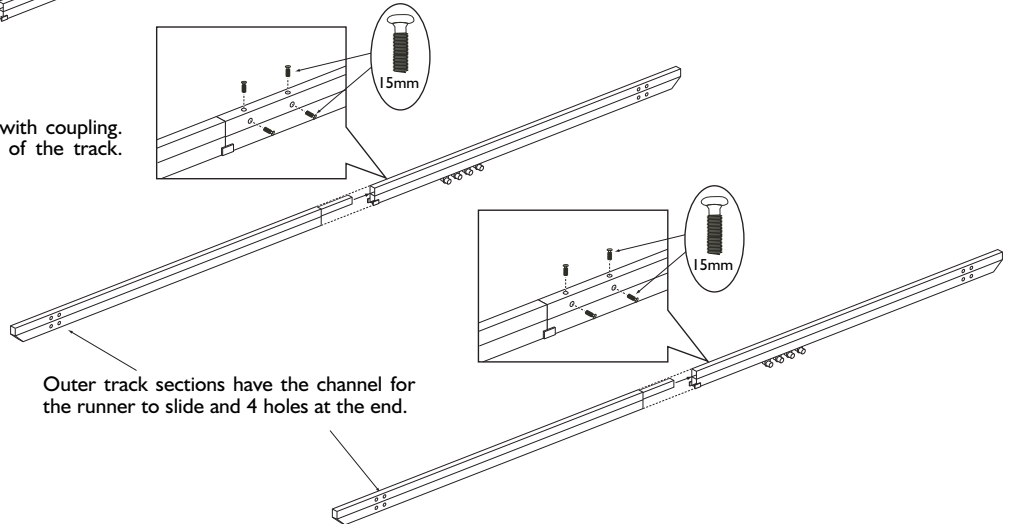

3. Front and back outer rafters

Connect the outer rafters to the outer rafters with coupling. Insert the coupling and secure in place using 3 x 15mm bolts for each join.

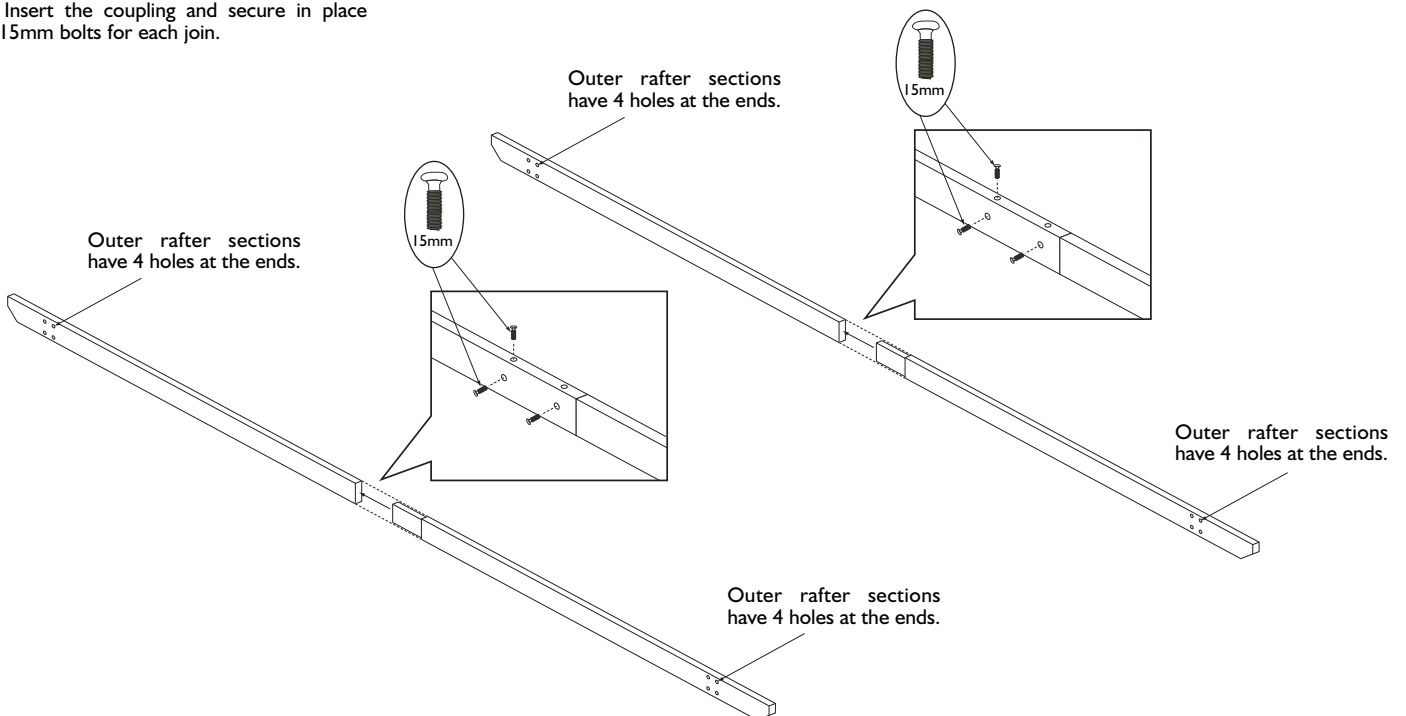

4. Outer track and rafters to legs

Attach the front outer rafter to the front legs as show using 4 x 15mm long head bolts per leg. Securing through the rafter into the leg. Attach the back outer rafter in the same way to the back legs. Join the 2 sections together with the outer track sections, attach the track sections using 4x15mm long head bolts at each end.

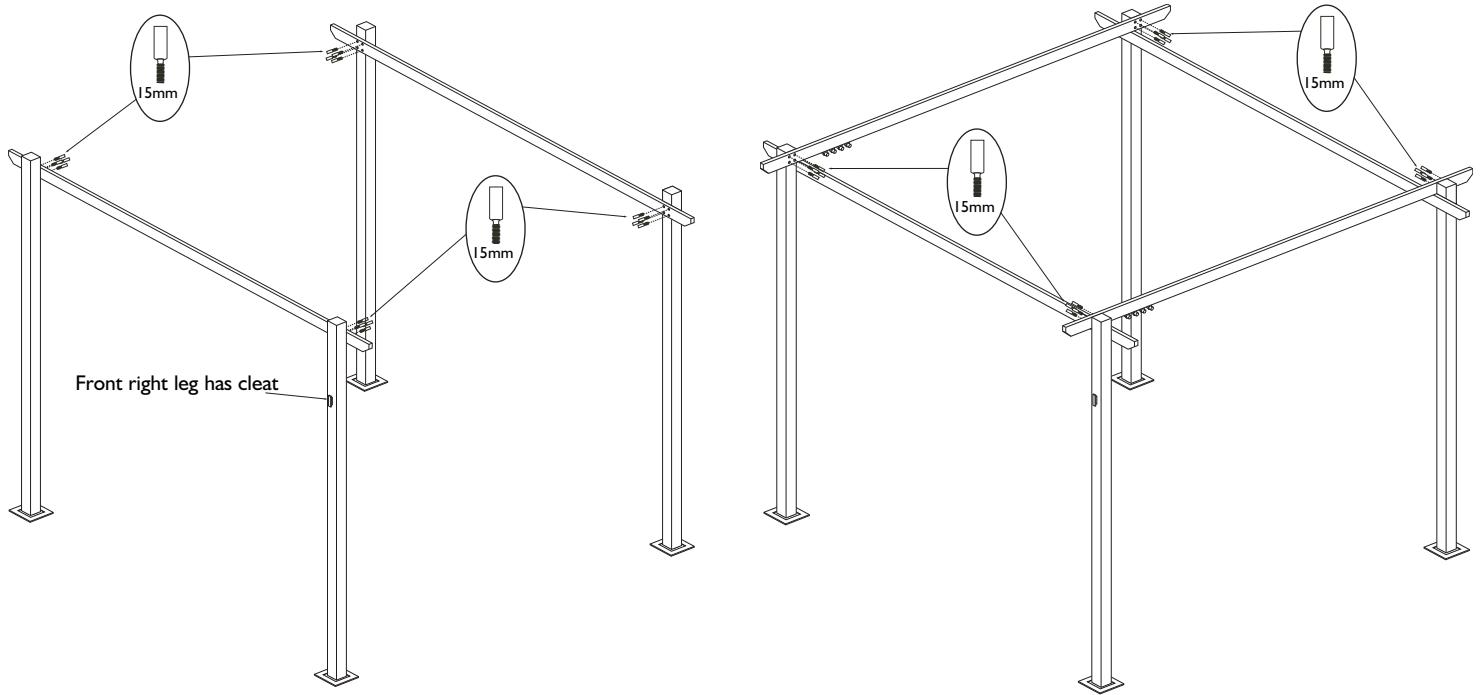

5. Centre track

Join the two halves of the centre track and pulley mechanism secure in place using 2 x 15mm bolts as shown. Position the centre track centrally on top of the main assembly and secure using 2 x 15mm bolts to the front outer rafter and 2 x 15mm bolts to the back outer rafter.

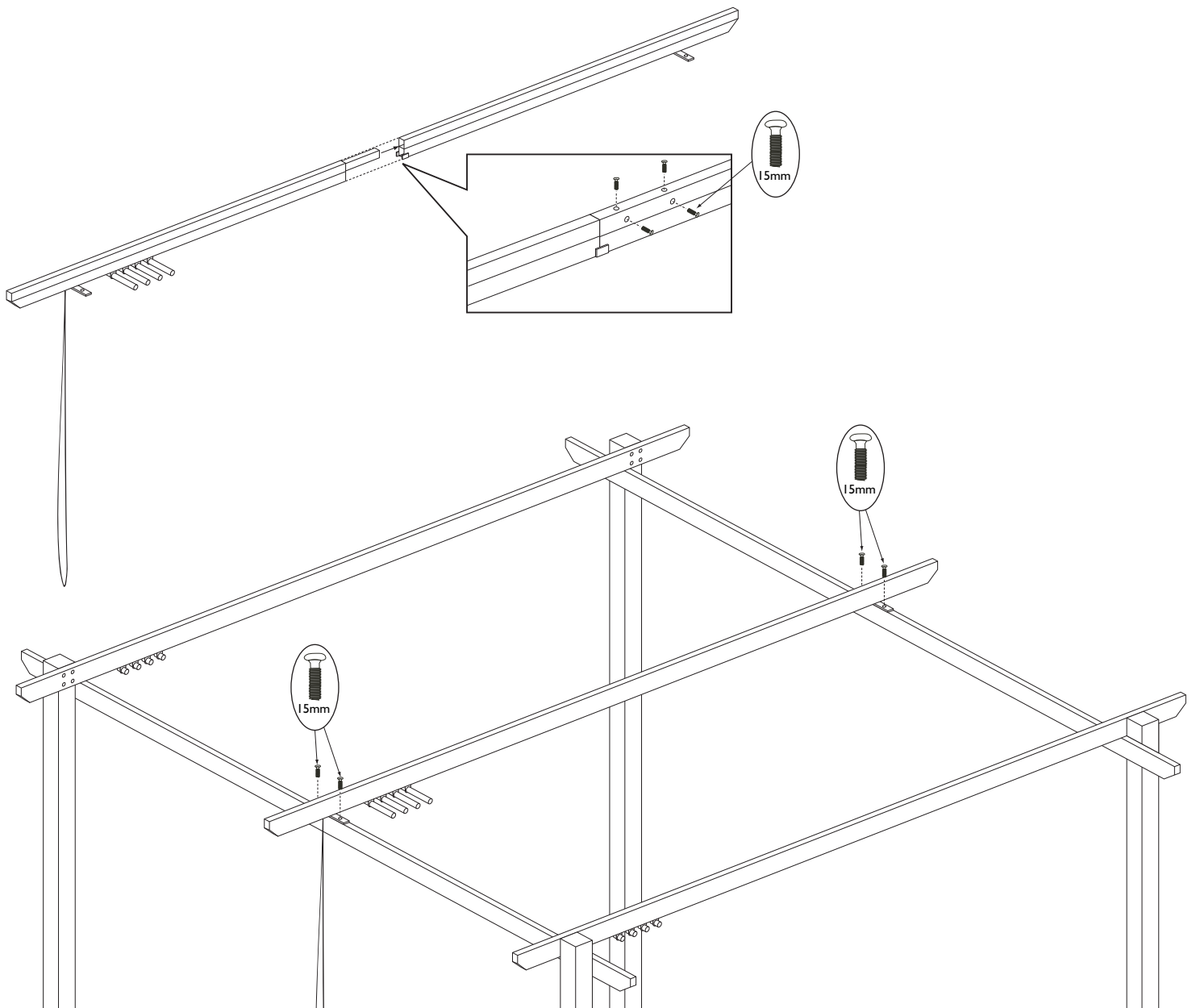

6. Centre rafters

Join each of the four centre rafter halves with coupling to centre rafters. Secure the rafter half using 2 x 15mm bolts. Place the rafters on the assembly and secure in place using 2 x 85mm bolts per rafter

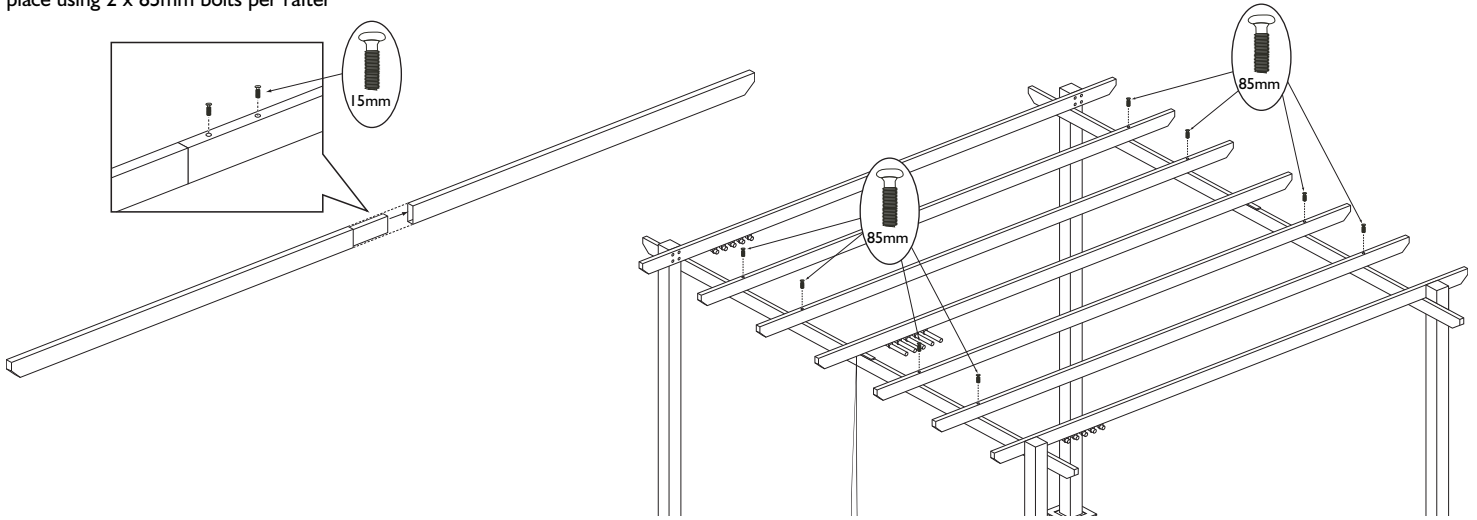

7. Attaching the canopy

Insert the two fixed canopy tubes in the end sleeves of the canopy as shown. Position the fixed canopy tubes against the inside of the back outer rafter and secure using 2 x 35mm bolts per tube.

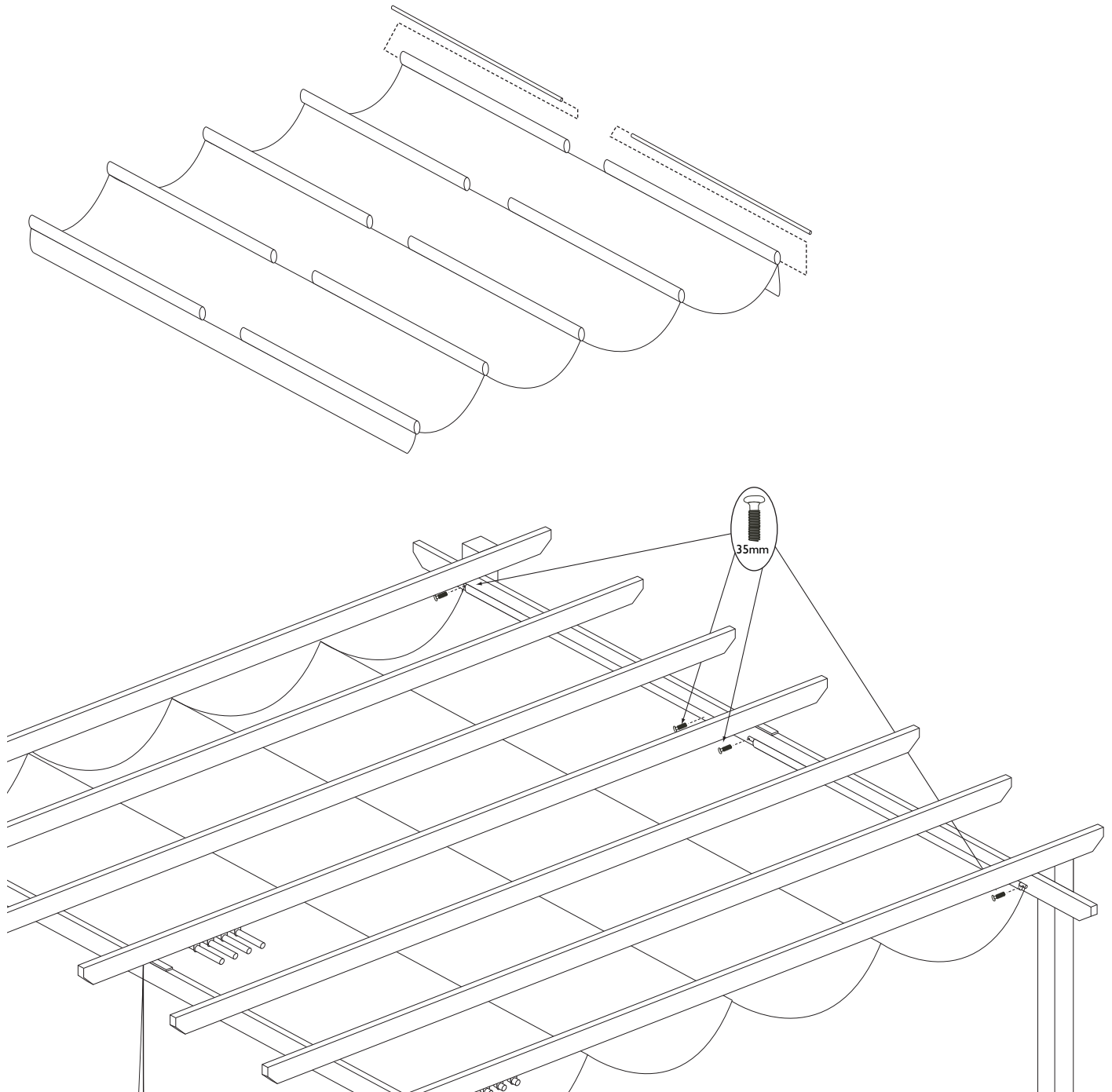

8. Attaching the polyester canopy to the runners

Push each of the 8 canopy tubes through the tube holders of the runners then through the sleeves in the canopy and connect to the centre runners, ensuring that the push button mechanism properly locates to lock components together.

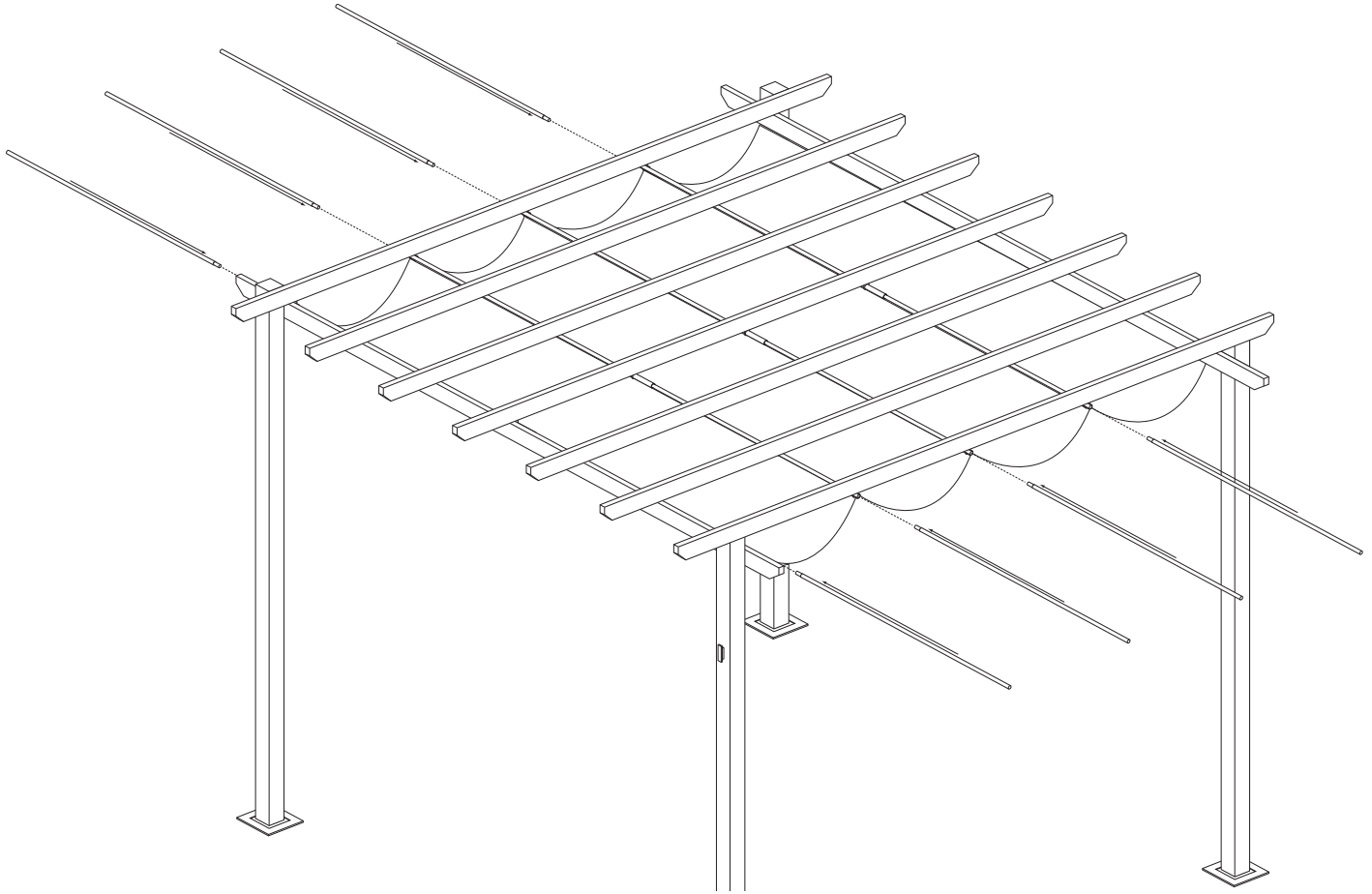

Important Information

- Please ensure that the canopy is erected on a stable, level and sturdy surface.
- Ideally, the canopy should be fixed to a level concrete patio base using appropriate fixings. If the canopy is to stand on grass, it is important that the canopy is level in order to ensure a smooth retracting mechanism, and the canopy should be secured into place using fixing pegs (supplied).
- Please note that this canopy is not designed to be used as a rain shelter, despite the polyester canopy being showerproof.
- We recommend that the polyester canopy be fully retracted when not in use.
- The polyester canopy should be fully removed in anticipation of strong winds and during the winter period.
- The polyester canopy must be completely dry before storage.
- Eyelets in the canvas are drain holes to prevent water collecting and stretching the canvas.

Maintenance

- To clean the polyester canopy, sponge clean using a mild soap and water solution and leave to dry naturally. Do not use bleach, acid or other solvents.
- Do not machine wash.
- Do not tumble dry.

Safety

In order to gain the most from your new canopy, attention should be paid to the following safety precautions:

1. Periodically check bolts and fittings for tightness as they may work loose over time, taking care not to over-tighten fittings as this may damage the metalwork. For this reason, we do not recommend the use of power tools to assemble the canopy.
2. Please note that the metal frame is not to be used as a climbing frame.

FIRE PRECAUTIONS

- PLEASE NOTE THAT THE CANOPY IS NOT FIRE RETARDANT AND CAN BURN
- DO NOT USE NAKED FLAMES IN THE VICINITY OF THE CANOPY
- BARBECUES AND/OR PATIO HEATERS SHOULD NOT BE USED EITHER UNDERNEATH OR IN THE VICINITY OF THE CANOPY

If in doubt of any aspect regarding the assembly, use or safety of your canopy please contact us :

Help Line (Normal Office Hours) 01829 261 121

ROWLINSON GARDEN PRODUCTS LIMITED
Green Lane
Wardle Nr.Nantwich
Cheshire
CW5 6BN

We constantly improve the quality of our products, occasionally the components shown and are only correct at time of printing. We reserve the right to change the specification of our products without prior notice.

2014 © Rowlinson Garden Products Ltd